















## **MOFFAT® E27MS on the A28CW**

### **Full Size Electric Convection Oven on a Stainless Steel Stand**

-  Commercial construction
-  3 full pan capacity
-  2 wire racks supplied
-  Bi-direction reversing fan system
-  15 amp plug-in (NEMA 6-15P)
-  60 minute bake timer
-  Stainless steel outer
-  Stainless steel door with full viewing window
-  Heavy duty stainless steel door handle
-  Insulated porcelain inner
-  Internal lighting
-  Stand constructed in stainless steel
-  Casters standard
-  Rack supports



E27MS shown on optional A28CW stand



**Order Toll Free 1800 551 8795**

#### **E27MS on A28CW**

Unit shall be a Moffat electrically heated Turbofan convection oven E.T.L. listed (UL Std 197) and NSF-4 listed. The oven shall have a one piece vitreous porcelain enamel oven liner, stainless steel top and sides with single stainless steel door and full viewing window. Oven liner shall be insulated on all sides and have capacity for three full size sheet pans. The oven shall have a bi-direction single reversing fan system for oven bake circulation. The oven shall be controlled by a mechanical thermostat with a range from 120°F to 480°F, a 60 minute bake timer, and oven light switch. Oven shall be able to be bench mounted on 4" legs. Oven shall be fitted with a NEMA 6-15P cordset. The stand shall be constructed from stainless steel tube with casters, 2 swivel and 2 brake. It shall be fitted with 6 sets of tray runners suitable for 6 full size sheet pans or 12 half size sheet pans. The stand shall be fully compatible with, and support, Turbofan model E27.

# MOFFAT® E27MS on the A28CW

## Full Size Electric Convection Oven on a Stainless Steel Stand

### CONSTRUCTION E27

Stainless steel top and sides  
Porcelain oven interior  
Toughened twin pane door glass  
Strong and stylish door handle  
3 full pan capacity (2 wire racks included)  
Fully insulated  
Stainless steel control panel with overlay  
Fully enclosed motor at rear

### CONSTRUCTION A28

Stainless steel frame and rack supports  
Strong, robust and functional  
Casters, 2 swivel and 2 brake  
Supplied ckd for assembly on site

### CONTROLS

On/off switch  
Mechanical thermostat, variable between  
120°F to 480°F  
Bi-direction reversing fan system  
Oven light  
60 minute bake timer

### CLEANING AND SERVICING

Fully removable racks and fan baffle  
Easy clean surfaces  
Access to all controls from front panel  
No tools to replace lamps  
Removable gaskets - no tools required

### SPECIFICATIONS

**Electrical requirements**  
208V, 50/60Hz, 1P+N+E, 3.0kW, 14.4A  
220-240V, 50/60Hz, 1P+N+E, 3.0kW, 12.5A  
NEMA 6-15P cordset fitted

### External Dimensions

Width 37 1/4" (945mm)  
Height 51 3/8" (1305mm)  
Depth 28 1/2" (725mm)

### Internal Dimensions

Width 27 3/8" (695mm)  
Height 11 1/4" (285mm)  
Depth 19 7/8" (505mm)

### Oven Volume

3.5 ft<sup>3</sup> (0.10m<sup>3</sup>)

### Oven Rack Dimensions

Depth 18" (460mm)  
Width 26" (660mm)

### Nett Weight (Total)

170lbs (77kg)

### Packing Data E27

227lbs (103kg)  
16.25ft<sup>3</sup> (0.46m<sup>3</sup>)  
Width 38 3/4" (985mm)  
Height 22" (560mm)  
Depth 33" (840mm)

### Packing Data A28

44lbs (20kg)  
4.2ft<sup>3</sup> (0.12m<sup>3</sup>)  
Width 35 1/2" (900mm)  
Height 36 1/4" (920mm)  
Depth 5 3/4" (145mm)

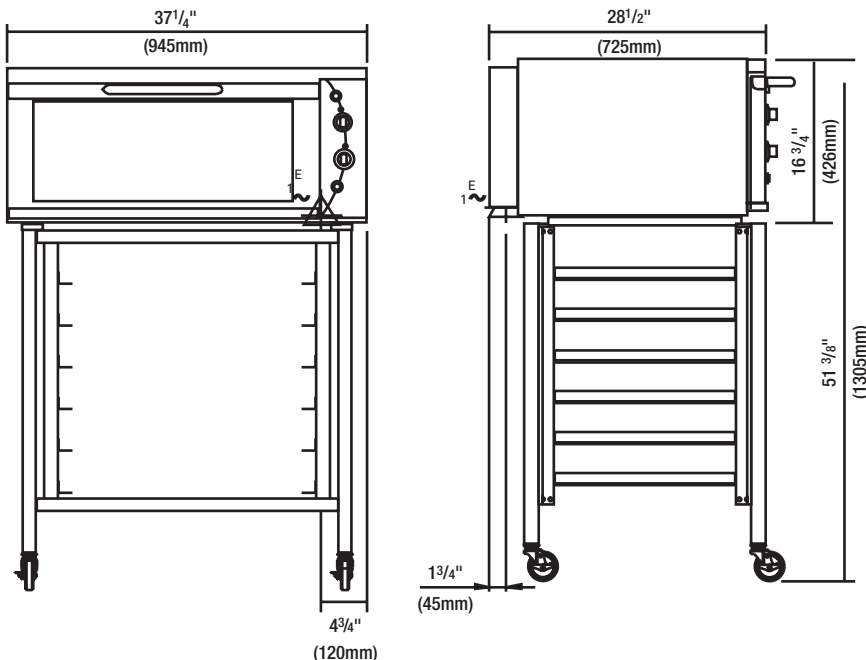

E27MS shown on optional A28CW stand

**MOFFAT®**

www.moffat.com

### U.S.A

**Moffat Inc**  
3765 Champion Boulevard  
Winston-Salem  
North Carolina 27105  
Call Free 1800 551 8795  
Ph 336-661 0257  
Fax 336-661 9546  
Email sales@moffat.com  
www.moffat.com

### Canada

**Serve Canada**  
22 Ashwarren Road  
Downview  
Ontario M3J1Z5  
Ph 416-631 0601  
Fax 416-631 7687  
Email info@servecanada.com

### Australia

**Moffat Pty Limited**  
740 Springvale Rd  
Mulgrave  
Victoria 3170  
Australia  
Ph 03-9518 3888  
Fax 03-9518 3833  
Email vsales@moffat.com.au  
www.moffat.com.au

### New Zealand

**Moffat Limited**  
16 Osborne St  
PO Box 10-001  
Christchurch  
New Zealand  
Ph 03-389 1007  
Fax 03-389 1276  
Email sales@moffat.co.nz  
www.moffat.co.nz

### United Kingdom

**Blue Seal Limited**  
Units 6-7 Mount St  
Business Park  
Birmingham B7 5QU  
England  
Ph 0121-327 5575  
Fax 0121-327 9711  
Email sales@blue-seal.co.uk  
www.blue-seal.co.uk

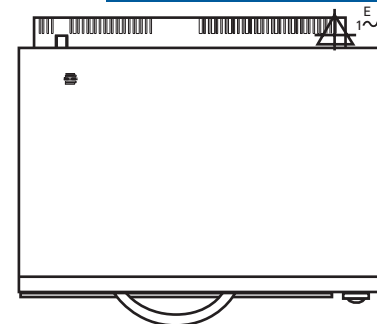

**ISO 9001**  
All Turbofan products are designed and manufactured by Moffat Ltd using the internationally recognised ISO 9001 quality management system, covering design, manufacture and final inspection, ensuring consistent high quality at all times.

